

Exceptional Engineering Research That Has Taken Longer
Than Everyone Thought It Would

Emma J. Student

A dissertation submitted to the faculty of
Brigham Young University
in partial fulfillment of the requirements for the degree of
Doctor of Philosophy

Norman D. Smith, Chair
Mary Q. Scott
Steven R. Jones
Anna B. Hanna

Department of Electrical and Computer Engineering
Brigham Young University

Copyright © 2024 Emma J. Student

All Rights Reserved

*Exceptional Engineering Research
That Has Taken Longer Than
Everyone Thought It Would*

Emma J. Student
Department of Electrical and Computer Engineering
Doctor of Philosophy

BYU Engineering

Abstract

The abstract is summary of the work with emphasis on the findings of the study. It is not intended to be an *introduction* to the research. Instead, it should concisely state the problem addressed, the methods developed and used, and the results obtained. It must be single spaced and no more than one page in length. It must use the same font and font size as the rest of the work. The abstract precedes the acknowledgment page and the body of the work. Lorem ipsum dolor sit amet, consectetur adipiscing elit. Etiam lobortis facilisis sem. Nullam nec mi et neque pharetra sollicitudin. Praesent imperdiet mi nec ante. Donec ullamcorper, felis non sodales commodo, lectus velit ultrices augue, a dignissim nibh lectus placerat pede. Vivamus nunc nunc, molestie ut, ultricies vel, semper in, velit. Ut porttitor. Praesent in sapien. Lorem ipsum dolor sit amet, consectetur adipiscing elit. Duis fringilla tristique neque. Sed interdum libero ut metus. Pellentesque placerat. Nam rutrum augue a leo. Morbi sed elit sit amet ante lobortis sollicitudin. Praesent blandit blandit mauris. Praesent lectus tellus, aliquet aliquam, luctus a, egestas a, turpis. Mauris lacinia lorem sit amet ipsum. Nunc quis urna dictum turpis accumsan semper.

Keywords: awesome stuff, killer app, buzz words

Acknowledgments

Students should acknowledge funding sources. They may also use the acknowledgment page to express appreciation for the committee members, friends or family who provided support or aided the research, writing or technical aspects of the thesis/dissertation. Acknowledgments should be simple and in good taste. Lorem ipsum dolor sit amet, consectetur adipiscing elit. Etiam lobortis facilisis sem. Nullam nec mi et neque pharetra sollicitudin. Praesent imperdiet mi nec ante. Donec ullamcorper, felis non sodales commodo, lectus velit ultrices augue, a dignissim nibh lectus placerat pede. Vivamus nunc nunc, molestie ut, ultricies vel, semper in, velit. Ut porttitor. Praesent in sapien. Lorem ipsum dolor sit amet, consectetur adipiscing elit. Duis fringilla tristique neque. Sed interdum libero ut metus. Pellentesque placerat. Nam rutrum augue a leo. Morbi sed elit sit amet ante lobortis sollicitudin. Praesent blandit blandit mauris. Praesent lectus tellus, aliquet aliquam, luctus a, egestas a, turpis. Mauris lacinia lorem sit amet ipsum. Nunc quis urna dictum turpis accumsan semper.

Table of Contents

List of Figures	vi
List of Tables	vii
Nomenclature	viii
1 Introduction	1
1.1 Class Options	1
1.2 Document Formatting	1
2 Additional L ^A T _E X Formatting	6
2.1 More L ^A T _E X Usage Examples	6
2.2 Bibliography	6
2.3 Use of Units	7
2.4 Capitalization of Reference Labels	8
2.5 Algorithms	8
2.6 Landscape Drawings and Tables	8
3 Article-based Chapters	11
3.1 Some Additional Comments	11
4 Conclusions	12
References	13
Appendices	14
A College of Engineering Formatting Requirements	15
B Electronic Document Submission	17
B.1 PDF Bookmarks	17
B.2 Miscellaneous Filler	18

List of Figures

- 1.1 This is a regular figure with a centered bottom caption. 2
- 1.2 This is an example of a margin figure. 3
- 1.3 This is a figure with a side caption that is not short, but not that long either. 3
- 1.4 The caption for a full-width figure appears in the margin below it. 3

- 2.1 Short caption to appear in list of figures. 6
- 2.2 Example of full-page landscape drawing. 10

- B.1 PDF thesis document showing ETD bookmarks. 17

List of Tables

- 1.1 This is a standard table with a top caption. 4
- 1.2 This is a standard table with a side caption. 5

Nomenclature

α	Angle of attack
β	Sideslip angle
γ	Climb angle
\mathbf{x}	State vector
Re	Reynolds number
c	Speed of light in a vacuum inertial frame
h	Planck constant
P	Covariance matrix
p	Roll rate
q	Pitch rate
r	Yaw rate

Introduction

The opening chapter of a thesis or dissertation will typically provide an introduction to the body of research. At the beginning of a chapter, it is common to provide some introductory text. Instead of discussing research, this template document will highlight how the `byuthesis` class and \LaTeX can be used to prepare a thesis or dissertation document for submission in the College of Engineering at BYU. A concise statement of the College of Engineering formatting requirements can be found in Appendix A.

1.1 Class Options

The `byuthesis` class has two class options. The first option allows the author to choose between a *simple* or *fancy* document format. The simple format is traditional in style and straightforward to implement using a standard word processor or \LaTeX . The fancy format leverages the advanced typesetting features of \LaTeX and the `memoir` class and more effectively utilizes the full letter-size page while following typesetting best practices. With the second class option, the author can specify whether the document fulfills the requirements for a masters or doctoral degree. For example, to use the `byuthesis` class for a doctoral dissertation in the simple format, the class definition (implemented on the first line of the `template.tex` file) would be `\documentclass[simple,phd]{byuthesis}`. To create a masters thesis in the fancy format, the definition would be `\documentclass[fancy,masters]{byuthesis}`. The example template document (`template.tex`) can be compiled using any combination of these options. Note that the simple and fancy formats use different source files for the chapters in this document. Be sure to uncomment the appropriate `chap*.tex` files in `template.tex`.

1.2 Document Formatting

The formatting and \LaTeX features that you will use to prepare your thesis are outlined briefly in the next several chapters. The narrow, single-column format of this document is based on long-standing principles of typography [1]. This formatting is easy to read compared to the wide-column, double-spaced format used previously for theses and dissertations. The format of the document is defined in `byuthesis.cls`, a \LaTeX class defined specifically for theses and dissertations in the

[1] Bringhurst, *The Elements of Typographic Style*, 2019.

College of Engineering at BYU. To give a better sense of the format of the document, we will occasionally throw in some random Latin text to take up white space. We set it apart from the text requiring your attention with a grey font color.

Lorem ipsum dolor sit amet, consectetur adipiscing elit. Etiam lobortis facilisis sem. Nullam nec mi et neque pharetra sollicitudin. Praesent imperdiet mi nec ante. Donec ullamcorper, felis non sodales commodo, lectus velit ultrices augue, a dignissim nibh lectus placerat pede. Vivamus nunc nunc, molestie ut, ultricies vel, semper in, velit.

When using the fancy option of `byuthesis.cls`, footnotes appear as sidenotes in the right margin.^a You can make a reference to a section by using its label, such as Section 1.2. You can reference a chapter in this way, for example Chapter 1. Here is an example of a citation of a master's thesis [2]. References for this template document are held in a file called `references.bib`. A complete list of the references cited in this document can be found in the References section at the end of the document before the Appendices.

^aThis is a sidenote created with the `\footnote` command.

[2] Tree, "Development of a Heat Flux Gauge for a Partially Insulated Internal Combustion Engine," 1988.

1.2.1 Including Figures and Tables

The syntax above provides an example for declaring a subsection. This subsection will include some text and give an examples of figures and tables. Let's start with figures. Figures are typically diagrams, graphs, pictures, maps, or charts. Figures should be centered with respect to the text column. Figure captions should be centered below the figure.^b If multiple lines are needed for the caption, it should be left/right justified at the margins. Figure 1.1 shows the gradient of a function and the half space where the function is decreasing. Notice how the `\ref` command automatically references the correct figure number. Notice also that the `~` inserts a non-breaking space, so that the label Figure and the figure number are never separated by a line break.

^bWe will introduces some alternative formats for figures and captions below that are enabled by the fancy option of the `byuthesis` class.

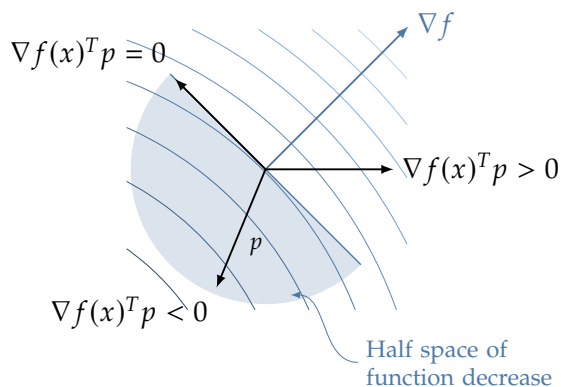

Figure 1.1: This is a regular figure with a centered bottom caption.

Lorem ipsum dolor sit amet, consectetur adipiscing elit. Etiam lobortis facilisis sem. Nullam nec mi et neque pharetra sollicitudin. Praesent imperdiet mi nec ante. Donec ullamcorper, felis non sodales

commodo, lectus velit ultrices augue, a dignissim nibh lectus placerat pede. Vivamus nunc nunc, molestie ut, ultricies vel, semper in, velit.

Figures should be placed after the paragraph in which they are first referenced. If a figure will not fit on the same page, continue the text and place the figure at the top of the next page. With the `bythesis.cls` document class, we can have small figures that are set in the sidemargin. Figure 1.2 is an example of a margin figure.

Lorem ipsum dolor sit amet, consectetur adipiscing elit. Etiam lobortis facilisis sem. Nullam nec mi et neque pharetra sollicitudin. Praesent imperdiet mi nec ante.

We can also create figures that place the caption in the side margin. Figure 1.3 is an example of this. This is a matter of personal preference. You can choose between centered captions and side-margin captions, but you should be consistent throughout your document.

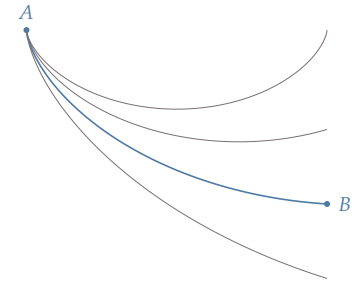

Figure 1.2: This is an example of a margin figure.

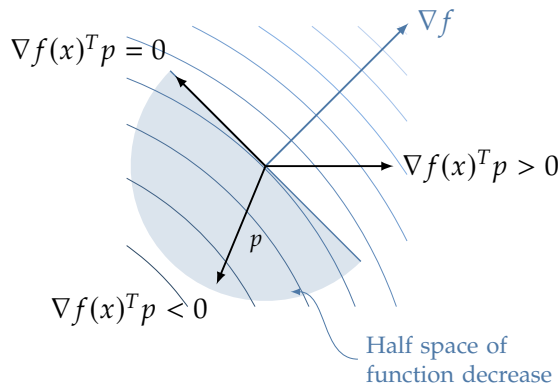

Figure 1.3: This is a figure with a side caption that is not short, but not that long either.

Finally, we can create a figure that spans the width of the text column and the side margin as shown in Figure 1.4. This option should not be used frequently as it requires some tweaking of the vertical distance of the caption and follow-on text below the figure. It will work robustly when the figure appears at the top or middle of a page, but may push the caption onto the next page when it appears at the bottom. There may be some instances with wide images where the additional manual adjusting is worth the effort.

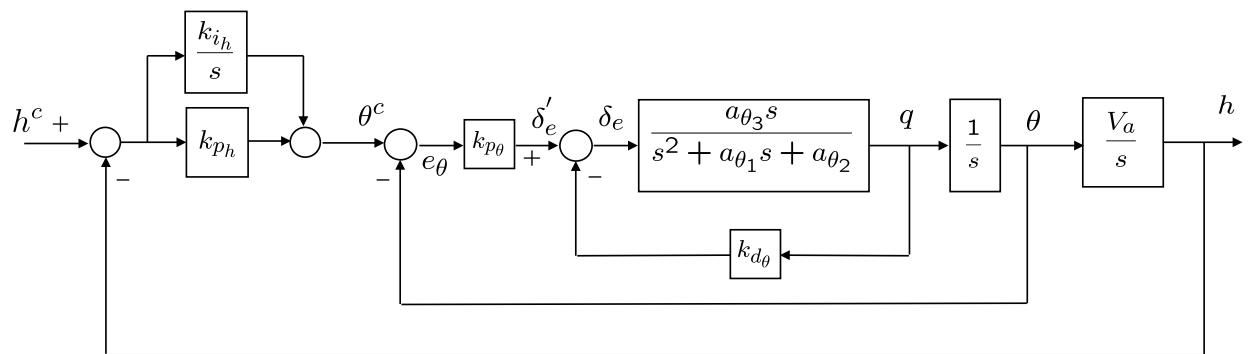

Figure 1.4: The caption for a full-width figure appears in the margin below it.

Table 1.1: This is a standard table with a top caption. More text is included in the title to show how multi-line titles should be left and right justified with the text column margins.

basin name	curve number	minimum	maximum
1B	68.5	49.2	84.1
2B	66.2	46.8	82.7
3B	65.4	45.5	82.3
average	66.7	47.2	83.0

Subsubsection Example

The syntax above provides an example of how to include a subsubsection. In this thesis template, the document has four primary division levels: `\chapter`, `\section`, `\subsection`, and `\subsubsection`. The command `\subsubsection` is used to define the lowest level of division. Notice that subsubsection titles are not numbered.

Including Tables

Tables typically contain numerical or statistical information. Tables are also fairly straightforward to include in a \LaTeX document. Table 1.1 shows a simple table. Tables are most commonly centered in the text column with the table caption centered above the table. If more than one line is needed for the caption it should be justified at the text margins as shown in Table 1.1.

\LaTeX refers to figures and tables as floats and often tries to locate figures at the top or bottom of a page. The user has some control over this, but \LaTeX can behave like it has a mind of its own sometimes. In reality it is placing figures according to internal algorithms and parameters that you can adjust. If you are interested in digging into this level of detail, an internet search on “*LaTeX float parameters*” will provide ample reading. In creating the table, we have used the command `\begin{table}[t]`. The parameter `[t]` allow us to specify preference for the location of table to be at the *top* of the page.

Table 1.2 shows an example of the same table using a side caption. We have used the placement preferences `[bht]` to give first preference to the *bottom* of the page, second preference to the current positioning in the source code (*here*), and third preference to the *top* of the page. As you can see, \LaTeX may override our preferences, based on the space available and its typesetting rules.

Notice that in the tables above, we have eliminated the vertical rules separating the columns. Doing so creates tables that are less cluttered and easier to read. If a table is to occupy a full page in landscape format, the top of the table should be on the left side of the page, with the caption above the table.

basin name	curve number	minimum	maximum
1B	68.5	49.2	84.1
2B	66.2	46.8	82.7
3B	65.4	45.5	82.3
average	66.7	47.2	83.0

Table 1.2: This is a standard table with a side caption.

1.2.2 Formatting Equations

Equation formatting is one of L^AT_EX's most useful features and a good reason why it is often used for theses and dissertations in the College of Engineering. It is easy to format equations within a sentence, such as $c = 2\pi r$ to describe the circumference of a circle. Equations should be treated as part of the text. As an example, the surface area of a cylinder is given by

$$S = 2\pi r (r + h), \quad (1.1)$$

where r is the radius of the cylinder and h is its height. The area of a circle can be expressed in terms of its diameter d as

$$A = \frac{\pi}{4}d^2. \quad (1.2)$$

Often, it is desirable to align a sequence of equations. Again, L^AT_EX makes this pretty easy. The roots of the polynomial function $f(x)$ can be found by factoring

$$f(x) = x^3 + 5x^2 + 6x \quad (1.3)$$

$$= x(x^2 + 5x + 6) \quad (1.4)$$

$$= x(x + 2)(x + 3), \quad (1.5)$$

setting each of the factors to zero, and solving for x . Equations without numbers can be typeset like this

$$x = a + b$$

or like this

$$y = c + d.$$

Just as we did with sections, figures, and tables, we can reference a specific equation by using its declared label. In (1.1), the surface area of a cylinder is defined. Another format would be to say Equation 1.2 defines the area of a circle. Yet another format is Eq. (1.2). Any of these formats is acceptable. Use just one of them and be consistent.

L^AT_EX can do so much with the typesetting of equations. These few examples are just a small sampling of its impressive capabilities.

Additional \LaTeX Formatting

In this chapter, we'll provide some additional guidelines and useful \LaTeX commands for formatting your document.

2.1 More \LaTeX Usage Examples

In Figure 2.1 below, we show some pretty blue and grey lines. This is the first figure in Chapter 2 and you can see that it is numbered accordingly. Notice that the `\ref` command automatically provides the correct numbering for the item being referenced. If you use the `\cref` command, the label (e.g., Figure, Chapter) will be added automatically. For figures and equations, however, `\cref` will abbreviate the labels (i.e., Fig. and Eq.). Either `\ref`, with label provided by you, or `\cref`, with automatic labeling, can be used.

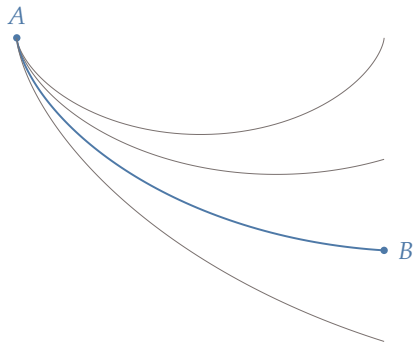

Figure 2.1: This is another figure. Some authors have paragraph-like descriptions of their figures that they put into the caption. This is acceptable, but readers don't really want or need a super long caption showing up in their list of figures. The `\caption` command provides a nice solution.

2.2 Bibliography

Another great feature of \LaTeX is that it allows you to create a list or database of books, papers, and other documents that you can easily cite in your document. In engineering, it is common to give your bibliography list the title References and we will follow that convention. \LaTeX automatically numbers the citations and builds a bibliography for you.^a The bibliography is typeset according the style you specify.

^aThe building of your bibliography is actually done by the `bibtex` package. If you use an IDE to work with \LaTeX , this may not be obvious to you.

The fancy format option of the `byuthesis.cls` class uses the `byubib` bibliography and citation style that produces a numbered list in order of citation. For this document, the file `references.bib` contains the bibliographic reference information that's available for citation in the thesis document. Each reference is created using a defined document type (e.g., `book` or `article`) and is given a cite key (a label) that is used to cite the reference. For example, here is a reference to a book [3] and a reference to a doctoral dissertation [4]. Journal articles [5] are treated differently than conference papers [6] since their references require slightly different information. Here is a reference to multiple sources at once [7–9]. As another example, here is a reference to a technical report [10] created using the `@techreport` document type. Websites can be cited as well [11] using the `@online` or `@electronic` document types. The fancy format produces a brief citation in the side margin where the reference is cited and a more detailed citation in the References section at the end of the document.

For each reference entry in your `.bib` file, different information fields will have to be populated. Examples of these fields include, *author*, *title*, *year*, and so on. Different types of publications will have different required fields for you to fill out. There are other types of citations that you may use, such as book chapters and websites. You can manually edit your `.bib` file with a text editor, or you can use one of the several popular apps that are available for editing and organizing your bibliography information (e.g., BibDesk, JabRef).

Digital object identifiers (DOI) enable some nice features within L^AT_EX. Notice that the *doi* field for the `journal1` reference in the `references.bib` file includes the DOI `10.1109/TAP.2004`. This DOI is automatically included as part of the reference in the References list at the end of the document. The DOI in the reference is an active hypertext link to the source document. (Go ahead and click on the DOI in the `template.pdf` document and see what happens.) For citations with a DOI, the title of the citation in the side margin is also an active link to the source document. For all of the side-margin citations, clicking on the citation number will take you to the full reference in the Reference section. From the Reference section, clicking on the citation page number in the side margin will take you back to the location in the document where the reference was originally cited. These features are really great when reading the PDF form of the thesis electronically.

2.3 Use of Units

Units should be appropriately used for all measurements and data presented in the document. Standard abbreviations for units (e.g., m for meters, N for newtons, in. for inches) should be used whenever data is presented. For example, the shaft was 1.23 cm in diameter. Notice that there is a space between the number and the unit, and the unit is typeset in vertical (roman) text and is *not italicized*. Italics is reserved for emphasis and for mathematical variables. Periods are not used after

[3] Howell, *Compliant Mechanisms*, 2001.

[4] Fletcher, "A Two-dimensional Model for Goal Gasification and Combustion," 1983.

[5] Jensen *et al.*, "A review of antennas and propagation for MIMO wireless communications," 2004.

[6] Swain *et al.*, "Tethys: A platform for water resources modeling and decision support apps," 2014.

[7] Beard *et al.*, "A coordination architecture for spacecraft formation control," 2001.

[8] Pitt *et al.*, "Ultrasound increases in the rate of bacterial cell growth," 2003.

[9] Webb *et al.*, "Single-phase liquid jet impingement heat transfer," 1995.

[10] Trawny *et al.*, "Indirect Kalman filter for 3D attitude estimation: A tutorial for quaternion algebra," 2005.

[11] "BYU College of Engineering," 2021.

abbreviations except in the special case of the abbreviation for inches as in. to avoid confusion with the word in. Units are typically spelled out when they are used without data. For example, newtons are a measure of force, while kilograms are a measure of mass.

2.4 Capitalization of Reference Labels

Throughout your document, you will refer to figures, tables, equations, chapters, appendices, and sections by name (e.g., Figure 2.1, Section 3.4, Equation 2.1, and so on). You may choose to capitalize these reference labels, or to leave them uncapitalized (e.g., figure 2.1, section 3.4, equation 2.1). The choice is yours, just be consistent – all reference labels should be capitalized, or uncapitalized.

2.5 Algorithms

Software and algorithm development can play an important role in graduate research. Rather than including software code, particularly in the body of the thesis, presenting your algorithms in the form of pseudo-code may be more desirable. The `algorithm` package in L^AT_EX provides tools for clearly presenting your algorithms. A simple example of the use of this package is presented in Algorithm 2.1.

Algorithm 2.1 Continuous-discrete extended Kalman filter.

```

1: Initialize:  $\hat{x} = 0$ .
2: Pick an output sample rate  $T_{out}$  that is much less than the sample
   rates of the sensors.
3: At each sample time  $T_{out}$ :
4: for  $i = 1$  to  $N$  do
5:    $\hat{x} = \hat{x} + \left(\frac{T_{out}}{N}\right) (f(\hat{x}, u))$ 
6:    $A = \frac{\partial f}{\partial x}$ 
7:    $P = P + \left(\frac{T_{out}}{N}\right) (AP + PA^T + GQG^T)$ 
8: end for
9: if a measurement has been received from sensor  $i$  then
10:   $C_i = \frac{\partial c_i}{\partial x}$ 
11:   $L_i = PC_i^T (R_i + C_i PC_i^T)^{-1}$ 
12:   $P = (I - L_i C_i) P$ 
13:   $\hat{x} = \hat{x} + L_i (y_i - c_i(\hat{x}))$ .
14: end if

```

2.6 Landscape Drawings and Tables

If you have a figure or table that is best presented in landscape format on a full page, the `rotating` package in L^AT_EX provides a convenient way to do this. Figure 2.2 on the following page shows an example a landscape-format drawing. Here is another reference to the Bringhurst

text on typography that is included to show how items cited multiple times show up in the References section [1].

[1] Bringhurst, *The Elements of Typographic Style*, 2019.

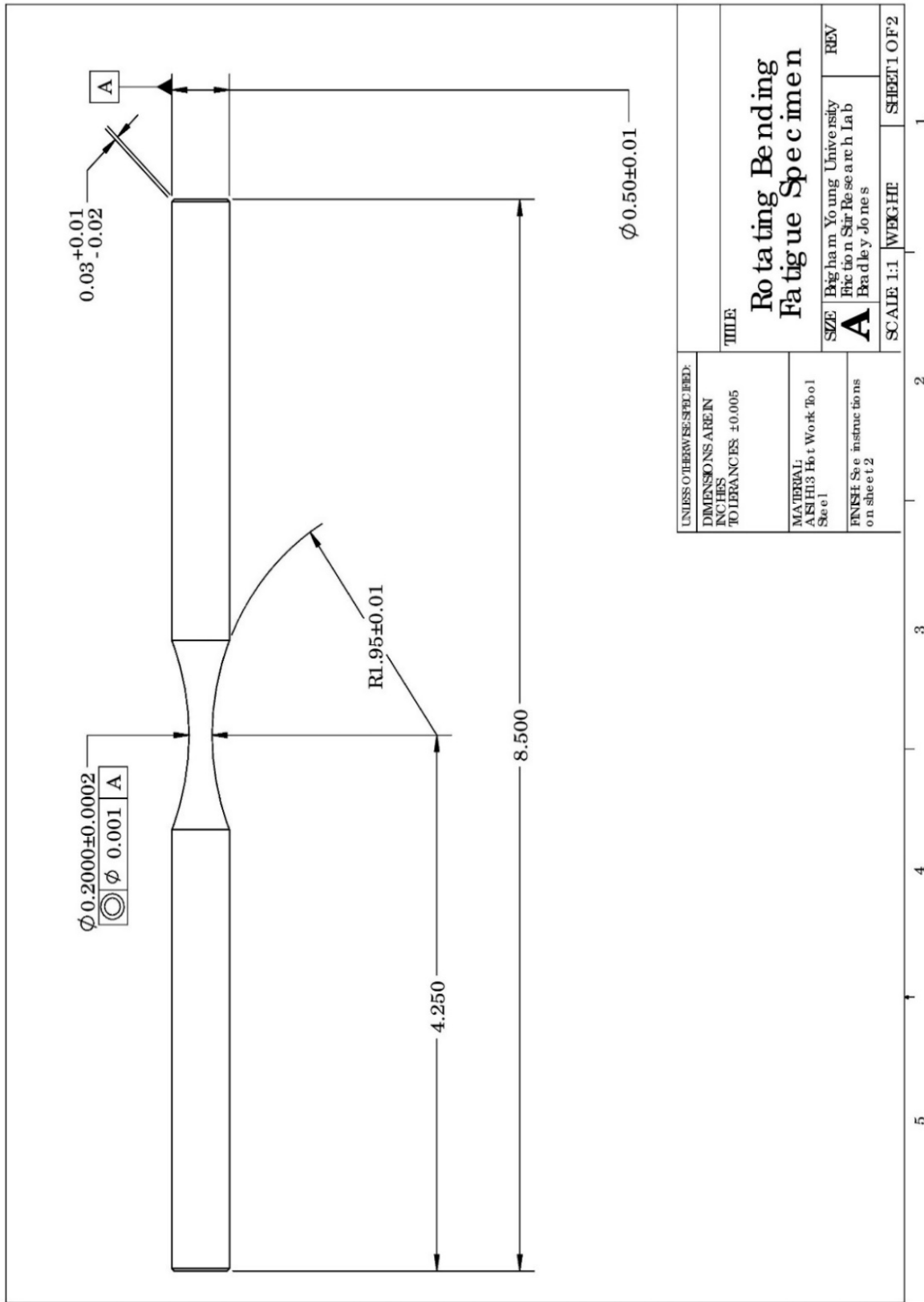

Figure 2.2: Example of full-page landscape drawing.

Article-based Chapters

With the recent changes in thesis and dissertation formatting, BYU Graduate Studies now allows students to insert journal or conference articles as chapters into their thesis/dissertation document. If approved by the department, a student in the College of Engineering may insert article-based chapters into their document. To do so, the student must be a primary author. The formatting of an article-based chapter must be fully consistent with the formatting defined in this document with chapter, section, equation, figure, and table numbering integrated accordingly. Article-based chapters must include a complete citation and the following statement: “I hereby confirm that the use of this article is compliant with all publishing agreements.” The paragraph below is an example of how this could be done. It should appear immediately following the chapter title.

This chapter is composed from a paper entitled “Really great research from a BYU engineering student” published in the journal *Awesome Engineering* [12]. I hereby confirm that the use of this article is compliant with all publishing agreements.

[12] Student *et al.*, “Really great research from a BYU engineering student,” 2020.

3.1 Some Additional Comments

The publication of a conference or journal article is a significant milestone for a graduate student and should be an objective for all students pursuing graduate research in the College of Engineering. We encourage the use of article-based chapters in theses and dissertations provided that it aligns with the goals and objectives of the research. Articles, however, are often constrained in length forcing the exposition to be more concise or narrow in scope than may be desired for the intended audience of the thesis/dissertation. For example, if an objective is to guide the learning of subsequent graduate-student researchers, it may be beneficial to include additional details or a broader discussion that may be more tutorial in nature. Often more results from a wider variety of cases would be included in a dissertation or thesis than would be possible in a journal or conference publication. Your graduate committee will help guide your efforts in these matters.

4

Conclusions

The purpose of this template is to provide basic instructions in creating your dissertation/thesis document. If you need assistance with writing, please visit the Writing Center in the JKB or consult with your advisor. If you need assistance with L^AT_EX, there are tutorials and ample documentation online. You may want to consult with your graduate-student peers who use L^AT_EX. If you discover something that would make this template more useful, please feel free to make recommendations. Here is an arbitrary citation to demonstrate how items cited multiple times show up in the References [1].

[1] Bringhurst, *The Elements of Typographic Style*, 2019.

Regardless of whether this template or some other method of formatting is employed, you (the student) are responsible for following the guidelines found in Appendix A. Below is a brief checklist of things to look for as you review your thesis for formatting:

- Check numbering of sections, figures, tables, equations to make sure they are consistent. This is where you will be really glad that you are using L^AT_EX.
- Ensure that your table of contents, list of figures, and list of tables are up to date and that page numbers are correct. (Hurray for L^AT_EX!)
- Make sure all pages are numbered, beginning with the table of contents.
- Be sure there is no extra white space at the bottom of any page except for the final page of a chapter.
- Make sure there are no widows or orphans.^a

^aA *widow* occurs when the last line of a paragraph ends up on the first line of a page. An *orphan* occurs when the first line of a paragraph appears on the last line of a page. Your document may require manual tweaking when it is in final form to get rid of widows and orphans.

References

- [1] Bringhurst, R., *The Elements of Typographic Style*, Fourth. Hartley & Marks Publishers, 2019. cited on pp. 1, 9, 12
- [2] Tree, D. R., "Development of a Heat Flux Gauge for a Partially Insulated Internal Combustion Engine," M.S. thesis, Purdue University, 1988. cited on p. 2
- [3] Howell, L. L., *Compliant Mechanisms*. New York, N.Y.: John Wiley & Sons, 2001. cited on p. 7
- [4] Fletcher, T. H., "A Two-dimensional Model for Coal Gasification and Combustion," Ph.D. dissertation, Brigham Young University, 1983. cited on p. 7
- [5] Jensen, M. and Wallace, J., "A review of antennas and propagation for MIMO wireless communications," *IEEE Transactions on Antennas and Propagation*, vol. 52, no. 11, 2004, pp. 2810–2824. DOI: 10.1109/tap.2004.835272 cited on p. 7
- [6] Swain, N., Christensen, S., Jones, N., and Nelson, E., "Tethys: A platform for water resources modeling and decision support apps," *American Geophysical Union, Fall Meeting*, 2014. cited on p. 7
- [7] Beard, R. W., Lawton, J., and Hadaegh, F. Y., "A coordination architecture for spacecraft formation control," *IEEE Transactions on Control Systems Technology*, vol. 9, no. 6, 2001, pp. 777–790. DOI: 10.1109/87.960341 cited on p. 7
- [8] Pitt, W. G. and Ross, S. A., "Ultrasound increases in the rate of bacterial cell growth," *Biotechnology progress*, vol. 19, no. 3, 2003, pp. 1038–1044. DOI: 10.1021/bp0340685 cited on p. 7
- [9] Webb, B. W. and Ma, C.-F., "Single-phase liquid jet impingement heat transfer," *Advances in heat transfer*, vol. 26, 1995, pp. 105–217. DOI: 10.1016/s0065-2717(08)70296-x cited on p. 7
- [10] Trawny, N. and Roumeliotis, S. I., "Indirect Kalman filter for 3D attitude estimation: A tutorial for quaternion algebra," 2005-002, Rev. 57, University of Minnesota, Department of Computer Science and Engineering, Minneapolis, 2005. cited on p. 7
- [11] "BYU College of Engineering," 2021. URL: <https://engineering.byu.edu>. cited on p. 7
- [12] Student, A., Researcher, M., and Professor, S., "Really great research from a BYU engineering student," *Awesome Engineering*, vol. 1, no. 2, 2020, pp. 1–10. cited on p. 11

Appendices

College of Engineering Formatting Requirements



Theses and dissertations in the College of Engineering should follow the requirements outlined below.

- **BYU Graduate Studies requirements:** The document must include a title page, abstract, and table of contents. The title page must follow the format prescribed at <https://gradstudies.byu.edu/academics/thesis-and-dissertation>.
- **PDF requirements:** All fonts should be embedded in the PDF. The PDF file should include bookmarks for each chapter and heading that is present in the table of contents section.
- **Page size, margins, and line spacing:** US letter-sized pages with margins of at least 1 inch on all sides of the text column should be used. Line spacing should be single spaced and facilitate readability with no more than six lines per inch. If using notes and figures in the side margin as is done with the fancy class option of `byuthesis.cls`, the space between the text column and the side-margin column must be at least 0.125 inches and the space between the side-margin column and the edge of the page must be at least 0.5 inches.
- **Typeface and font:** The text typeface must be a conservative serif-styled type (e.g., Palatino, Times New Roman, Garamond), in size 11 or 12 pt font. The typeface style and font size must be consistent throughout the text. A 10 pt font is allowed for figure and table captions. Font sizes for figures and tables should be selected so that the text easily legible on a printed page. A sans-serif typeface can be used for chapter and section headings if desired.
- **Use of color:** The main text of the document should be black in color. Color can be used judiciously in the document for items such as chapter names and numbers, section names and numbers, and figure and table labels. Colors of text should be limited to black, grey (0x666666), navy blue (0x002E5D), and royal blue (0x005CAB) as specified by university style guides at <https://brand.byu.edu/colors>.
- **Page numbering:** Preliminary matter should be numbered with lowercase Roman numerals (i, ii, and so forth) starting with the

Table of Content page. Main matter beginning with the first page of the first chapter should be numbered consecutively with Arabic numerals starting with 1.

- **Chapters, sections, and appendices:** The document should be divided into chapters. Within chapters, section and subsection headings should be set off with titles. Appendices may be included after the list of references.
- **References:** Works cited in the document should be included in a list of references after the last chapter and before appendices. References should be cited in the text using a standard format such as (author, year) or by number (e.g., [1]). The list of references should follow a standard format and must include sufficient information for the work to be located.
- **Equations:** Equations that are referenced in the text should be numbered in the format (chapter.number), so that the first referenced equation in Chapter 2 is numbered (2.1) and referenced in the text in the same format.
- **Figures and tables** should be numbered in the format Figure chapter.number, as in Figure 2.1 or Table 3.2. Tables and figures appearing in appendices should be numbered A.1, A.2, B.1, and so forth. Figures should include a descriptive caption below the figure. Tables should include a descriptive title above the table.
- **Article-based chapters:** If permitted by the thesis and dissertation formatting requirements of the department, submitted, accepted, or published articles for which the student is a primary author may be inserted as chapters in the thesis or dissertation. The inserted article text must be formatted in the same format as the other chapters of the document with consistent page numbering. Article-based chapters should provide a citation to the article and a brief statement of its publication status at the time of submission of the thesis/dissertation.
- **General formatting:** Documents should follow formatting and typographic best practices and avoid common errors such as widow or orphan lines and excessive white space. Care should be taken to maintain a consistent typographic style throughout the document. Inconsistent usage of typefaces or fonts (e.g., italic, bold, etc.) are not generally acceptable. If uncertain, stick with the formatting of the provided templates.

B

Electronic Document Submission

The university requires all dissertations and theses to be submitted electronically as a PDF document. All required fonts should be embedded in the PDF document to ensure that your document will appear as intended wherever it is viewed. You can verify that all fonts are appropriately embedded by opening your PDF document in Adobe Acrobat Reader and selecting File->Properties. Under the Font tab, you should see a list of the fonts used in your document. To ensure that all fonts are embedded, they should be designated as “Embedded” or “Embedded Subset” in the list.

B.1 PDF Bookmarks

The PDF document must contain bookmarks for preliminary pages plus chapter headings and subheadings, as listed in the Table of Contents. In the PDF document, bookmarks should be displayed in a panel to the left of the document pages as seen in Figure B.1.

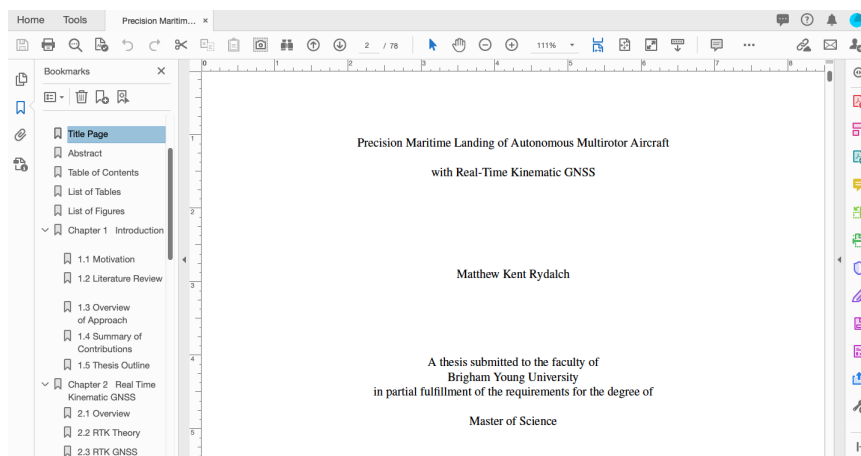

Figure B.1: PDF thesis document showing ETD bookmarks.

If assistance is needed with embedding, bookmarks, or other aspects of submitting the ETD, you may obtain assistance at the Multimedia Lab in the HBL. Please note that keywords for your research will be required at the time you submit your document. Keywords must be in lower case, unless they are acronyms or proper nouns. In addition, a copy of the

abstract must be inserted. Helpful information on submitting your ETD copy can be found at <https://gradprogress.sim.byu.edu/resources>.

B.2 Miscellaneous Filler

Most appendices will be longer than 3/4 of a page. We'll use some Latin to fill this one out. Lorem ipsum dolor sit amet, consectetur adipiscing elit. Etiam lobortis facilisis sem. Nullam nec mi et neque pharetra sollicitudin. Praesent imperdiet mi nec ante. Donec ullamcorper, felis non sodales commodo, lectus velit ultrices augue, a dignissim nibh lectus placerat pede. Vivamus nunc nunc, molestie ut, ultricies vel, semper in, velit. Ut porttitor. Praesent in sapien. Lorem ipsum dolor sit amet, consectetur adipiscing elit. Duis fringilla tristique neque. Sed interdum libero ut metus. Pellentesque placerat. Nam rutrum augue a leo. Morbi sed elit sit amet ante lobortis sollicitudin. Praesent blandit blandit mauris. Praesent lectus tellus, aliquet aliquam, luctus a, egestas a, turpis. Mauris lacinia lorem sit amet ipsum. Nunc quis urna dictum turpis accumsan semper.